

JB SANITARY

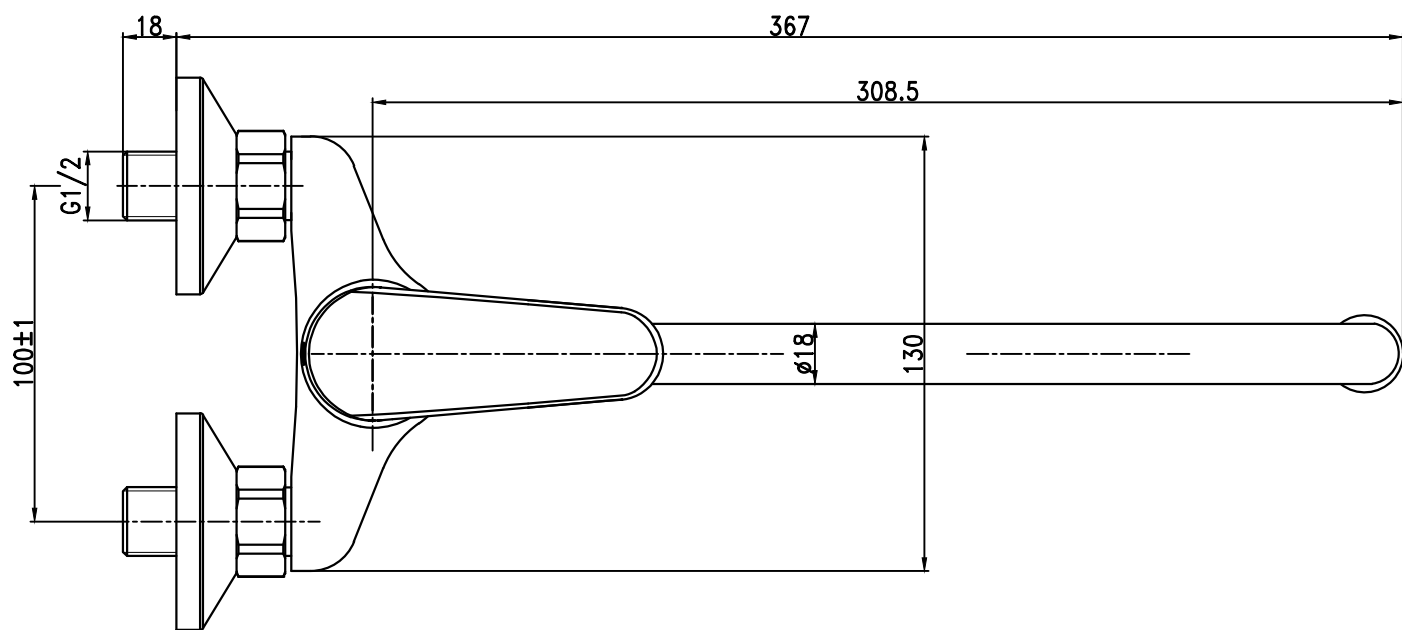
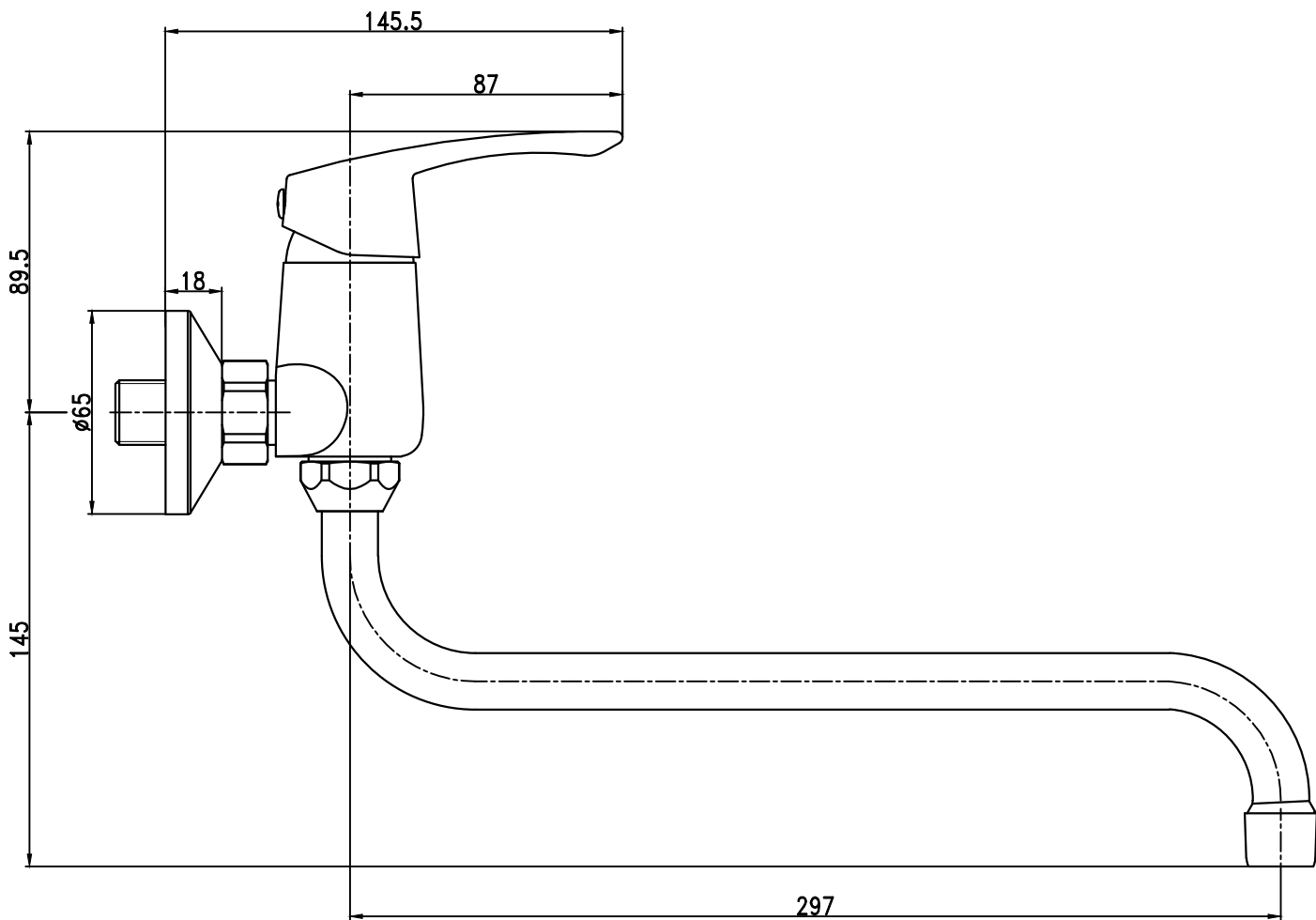

L10 30 50